

Generalized Yang-Mills Fields and Gauge fields in $(A)dS_d$

E.D. Skvortsov

Lebedev Institute, Moscow

SFT, April 17, 2009

Gravity as a Gauge Theory

$$g_{\mu\nu} \longrightarrow h_{\mu}^a, \varpi_{\mu}^{a,b}$$

Yang-Mills field $A_{\mu}dx^{\mu} = (P_a h_{\mu}^a + L_{a,b} \varpi_{\mu}^{a,b}) dx^{\mu}$

Algebra

$$\begin{aligned} [P_a, P_b] &= \pm \lambda^2 L_{ab} & \lambda^2 > 0 & \mathfrak{so}(d, 1) \\ [L_{ab}, L_c] &= L_a \eta_{bc} - L_b \eta_{ac} & \lambda^2 = 0 & \mathfrak{iso}(d-1, 1) \\ [L_{ab}, L_{cd}] &= L_{ad} \eta_{bc} + \dots & \lambda^2 < 0 & \mathfrak{so}(d-1, 2) \end{aligned}$$

Field strength $R = dA + [A, \wedge A] = P_a R^a + L_{a,b} R^{a,b}$

Torsion $R^a = dh^a + \varpi^a{}_b \wedge h^b = 0$

Curvature $R^{a,b} = d\varpi^{a,b} + \varpi^a{}_c \wedge \varpi^{c,b} \pm \lambda^2 h^a \wedge h^b = 0$

Gravity as a Gauge Theory

$$g_{\mu\nu} \longrightarrow h_{\mu}^a, \varpi_{\mu}^{a,b}$$

Yang-Mills field $A_{\mu}dx^{\mu} = (P_a h_{\mu}^a + L_{a,b} \varpi_{\mu}^{a,b}) dx^{\mu}$

Algebra

$$\begin{aligned} [P_a, P_b] &= \pm \lambda^2 L_{ab} & \lambda^2 > 0 & \mathfrak{so}(d, 1) \\ [L_{ab}, L_c] &= L_a \eta_{bc} - L_b \eta_{ac} & \lambda^2 = 0 & \mathfrak{iso}(d-1, 1) \\ [L_{ab}, L_{cd}] &= L_{ad} \eta_{bc} + \dots & \lambda^2 < 0 & \mathfrak{so}(d-1, 2) \end{aligned}$$

Field strength $R = dA + [A, \wedge A] = P_a R^a + L_{a,b} R^{a,b}$

Torsion $R^a = dh^a + \varpi^a{}_b \wedge h^b = 0$

Curvature $R^{a,b} = d\varpi^{a,b} + \varpi^a{}_c \wedge \varpi^{c,b} \pm \lambda^2 h^a \wedge h^b = 0$

Gravity as a Gauge Theory

$$g_{\mu\nu} \longrightarrow h_{\mu}^a, \varpi_{\mu}^{a,b}$$

Yang-Mills field $A_{\mu} dx^{\mu} = (P_a h_{\mu}^a + L_{a,b} \varpi_{\mu}^{a,b}) dx^{\mu}$

Algebra

$[P_a, P_b] = \pm \lambda^2 L_{ab}$	$\lambda^2 > 0$ $\mathfrak{so}(d, 1)$
$[L_{ab}, L_c] = L_a \eta_{bc} - L_b \eta_{ac}$	$\lambda^2 = 0$ $\mathfrak{iso}(d-1, 1)$
$[L_{ab}, L_{cd}] = L_{ad} \eta_{bc} + \dots$	$\lambda^2 < 0$ $\mathfrak{so}(d-1, 2)$

Field strength $R = dA + [A, \wedge A] = P_a R^a + L_{a,b} R^{a,b}$

Torsion $R^a = dh^a + \varpi^a_b \wedge h^b = 0$

Curvature $R^{a,b} = d\varpi^{a,b} + \varpi^a_c \wedge \varpi^{c,b} \pm \lambda^2 h^a \wedge h^b = 0$

Gravity as a Gauge Theory

$$g_{\mu\nu} \longrightarrow h_{\mu}^a, \varpi_{\mu}^{a,b}$$

Yang-Mills field $A_{\mu} dx^{\mu} = (P_a h_{\mu}^a + L_{a,b} \varpi_{\mu}^{a,b}) dx^{\mu}$

Algebra

$[P_a, P_b] = \pm \lambda^2 L_{ab}$	$\lambda^2 > 0$ $\mathfrak{so}(d, 1)$
$[L_{ab}, L_c] = L_a \eta_{bc} - L_b \eta_{ac}$	$\lambda^2 = 0$ $\mathfrak{iso}(d-1, 1)$
$[L_{ab}, L_{cd}] = L_{ad} \eta_{bc} + \dots$	$\lambda^2 < 0$ $\mathfrak{so}(d-1, 2)$

Field strength $R = dA + [A, \wedge A] = P_a R^a + L_{a,b} R^{a,b}$

Torsion $R^a = dh^a + \varpi^{a,b} \wedge h^b = 0$

Curvature $R^{a,b} = d\varpi^{a,b} + \varpi^{a,c} \wedge \varpi^{c,b} \pm \lambda^2 h^a \wedge h^b = 0$

Gravity as a Gauge Theory

$$d = 4$$

$$\frac{1}{\lambda^2} \int R^{a,b} \wedge R^{c,d} \epsilon_{abcd} \quad \sim \quad \int \sqrt{g} (R + \lambda^2) + \text{Gauss Bonnet}$$

$$d \geq 4$$

$$\frac{1}{\lambda^2} \int R^{a,b} \wedge R^{c,d} \epsilon_{abcde\dots u} h^e \dots h^u$$

Gravity as a Gauge Theory

$$d = 4$$

$$\frac{1}{\lambda^2} \int R^{a,b} \wedge R^{c,d} \epsilon_{abcd} \quad \sim \quad \int \sqrt{g} (R + \lambda^2) + \text{Gauss Bonnet}$$

$$d \geq 4$$

$$\frac{1}{\lambda^2} \int R^{a,b} \wedge R^{c,d} \epsilon_{abcde\dots u} h^e \dots h^u$$

Getting $(A)dS_d$ symmetry manifest

(MacDowell, Mansouri, Stelle, West, Vasiliev)

$$\Omega_{\mu}^{A,B} = -\Omega_{\mu}^{B,A}$$

$$A = 0, \dots, d(\bullet) = a, \bullet$$

$$R^{A,B} = d\Omega^{A,B} + \Omega^{A, C} \wedge \Omega^{C,B}$$

$$h^a = \lambda \Omega^{a, \bullet}$$

$$R^a = \lambda R^{a, \bullet}$$

$$\varpi^{a,b} = \Omega^{a,b}$$

$$R^{a,b} = R^{a,b}$$

Goldstone field

$$V^A V^B \eta_{AB} = \pm 1$$

Frame field

$$H^A = D_{\Omega} V^A = dV^A + \Omega^{A, C} V^C$$

Spin-connection

$$\Omega_L^{A,B} = \Omega^{A,B} \pm \lambda (H^A V^B - H^B V^A)$$

Standard gauge $V^A = \delta^A_{\bullet}$

$$\frac{1}{\lambda^2} \int R^{A,B} \wedge R^{C,D} \epsilon_{ABCDE\dots UN} H^E \dots H^U V^N$$

Getting $(A)dS_d$ symmetry manifest

(MacDowell, Mansouri, Stelle, West, Vasiliev)

$$\Omega_{\mu}^{A,B} = -\Omega_{\mu}^{B,A}$$

$$A = 0, \dots, d(\bullet) = a, \bullet$$

$$R^{A,B} = d\Omega^{A,B} + \Omega^{A, C} \wedge \Omega^{C,B}$$

$$h^a = \lambda \Omega^{a, \bullet}$$

$$R^a = \lambda R^{a, \bullet}$$

$$\varpi^{a,b} = \Omega^{a,b}$$

$$R^{a,b} = R^{a,b}$$

Goldstone field $V^A V^B \eta_{AB} = \pm 1$

Frame field $H^A = D_{\Omega} V^A = dV^A + \Omega^{A, C} V^C$

Spin-connection $\Omega_L^{A,B} = \Omega^{A,B} \pm \lambda (H^A V^B - H^B V^A)$

Standard gauge $V^A = \delta^A_{\bullet}$

$$\frac{1}{\lambda^2} \int R^{A,B} \wedge R^{C,D} \epsilon_{ABCDE\dots UN} H^E \dots H^U V^N$$

Getting $(A)dS_d$ symmetry manifest

(MacDowell, Mansouri, Stelle, West, Vasiliev)

$$\Omega_{\mu}^{A,B} = -\Omega_{\mu}^{B,A}$$

$$A = 0, \dots, d(\bullet) = a, \bullet$$

$$R^{A,B} = d\Omega^{A,B} + \Omega^{A, C} \wedge \Omega^{C,B}$$

$$h^a = \lambda \Omega^{a, \bullet}$$

$$R^a = \lambda R^{a, \bullet}$$

$$\varpi^{a,b} = \Omega^{a,b}$$

$$R^{a,b} = R^{a,b}$$

Goldstone field

$$V^A V^B \eta_{AB} = \pm 1$$

Frame field

$$H^A = D_{\Omega} V^A = dV^A + \Omega^{A, C} V^C$$

Spin-connection

$$\Omega_L^{A,B} = \Omega^{A,B} \pm \lambda (H^A V^B - H^B V^A)$$

Standard gauge $V^A = \delta^A_{\bullet}$

$$\frac{1}{\lambda^2} \int R^{A,B} \wedge R^{C,D} \epsilon_{ABCDE\dots UN} H^E \dots H^U V^N$$

Getting $(A)dS_d$ symmetry manifest

(MacDowell, Mansouri, Stelle, West, Vasiliev)

$$\Omega_{\mu}^{A,B} = -\Omega_{\mu}^{B,A}$$

$$A = 0, \dots, d(\bullet) = a, \bullet$$

$$R^{A,B} = d\Omega^{A,B} + \Omega^{A, C} \wedge \Omega^{C,B}$$

$$h^a = \lambda \Omega^{a, \bullet}$$

$$R^a = \lambda R^{a, \bullet}$$

$$\varpi^{a,b} = \Omega^{a,b}$$

$$R^{a,b} = R^{a,b}$$

Goldstone field

$$V^A V^B \eta_{AB} = \pm 1$$

Frame field

$$H^A = D_{\Omega} V^A = dV^A + \Omega^{A, C} V^C$$

Spin-connection

$$\Omega_L^{A,B} = \Omega^{A,B} \pm \lambda (H^A V^B - H^B V^A)$$

Standard gauge $V^A = \delta_{\bullet}^A$

$$\frac{1}{\lambda^2} \int R^{A,B} \wedge R^{C,D} \epsilon_{ABCDE\dots UN} H^E \dots H^U V^N$$

Getting $(A)dS_d$ symmetry manifest

(MacDowell, Mansouri, Stelle, West, Vasiliev)

$$\Omega_{\mu}^{A,B} = -\Omega_{\mu}^{B,A}$$

$$A = 0, \dots, d(\bullet) = a, \bullet$$

$$R^{A,B} = d\Omega^{A,B} + \Omega^A{}_{,C} \wedge \Omega^{C,B}$$

$$h^a = \lambda \Omega^{a,\bullet}$$

$$R^a = \lambda R^{a,\bullet}$$

$$\varpi^{a,b} = \Omega^{a,b}$$

$$R^{a,b} = R^{a,b}$$

Goldstone field

$$V^A V^B \eta_{AB} = \pm 1$$

Frame field

$$H^A = D_{\Omega} V^A = dV^A + \Omega^A{}_{,C} V^C$$

Spin-connection

$$\Omega_L^{A,B} = \Omega^{A,B} \pm \lambda (H^A V^B - H^B V^A)$$

Standard gauge $V^A = \delta^A_{\bullet}$

$$\frac{1}{\lambda^2} \int R^{A,B} \wedge R^{C,D} \epsilon_{ABCDE\dots UN} H^E \dots H^U V^N$$

Tensors and Young Diagrams

symmetric

$$T^{A\dots B\dots C} = T^{B\dots A\dots C}$$



antisymmetric

$$T^{A,B,\dots,C} = -T^{B,A,\dots,C}$$



mixed-symmetry

$$T^{AB\dots,D\dots, \dots, \dots,U}$$

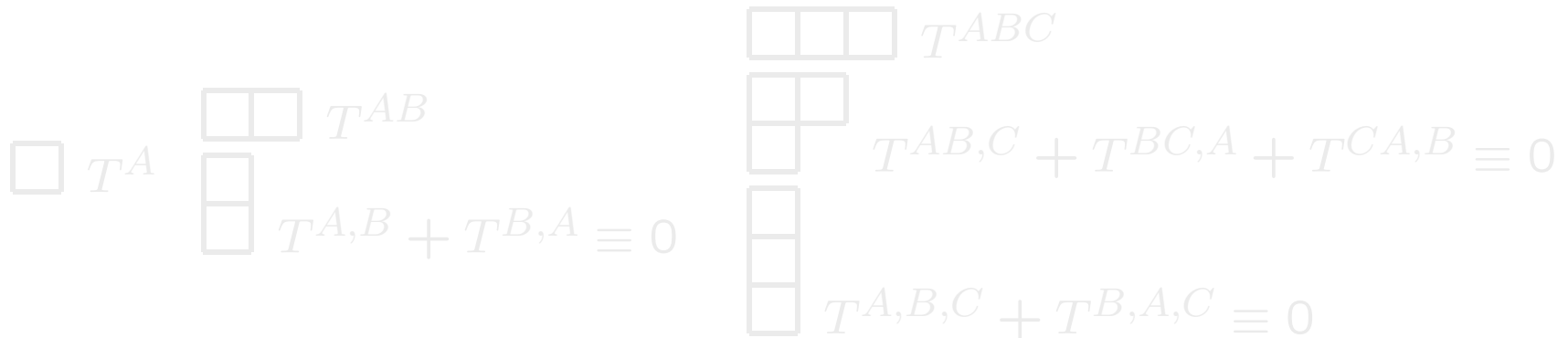
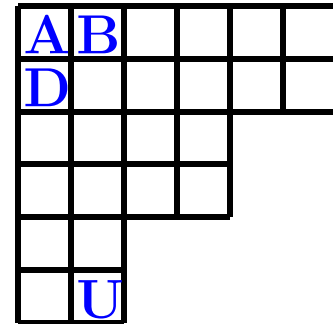

Tensors and Young Diagrams

symmetric

$$T^{A\dots B\dots C} = T^{B\dots A\dots C}$$



antisymmetric

$$T^{A,B,\dots,C} = -T^{B,A,\dots,C}$$



mixed-symmetry

$$T^{AB\dots,D\dots, \dots, \dots,U}$$

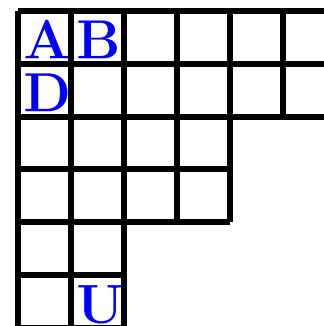

T^A



T^{AB}

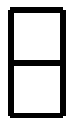

$$T^{A,B} + T^{B,A} \equiv 0$$

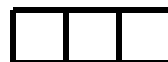

T^{ABC}

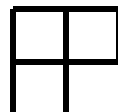

$$T^{AB,C} + T^{BC,A} + T^{CA,B} \equiv 0$$



$$T^{A,B,C} + T^{B,A,C} \equiv 0$$

Generalized Yang-Mills Connections

(Alkalaev, Shaynkman, Skvortsov, Vasiliev)

Yang-Mills Connection

$$W_\mu^{A,B} dx^\mu$$

one-form in adjoint = \mathfrak{g}



Generalized Yang-Mills Connection

q -form in arbitrary module A

$$W_q^A \equiv W_{\mu_1 \dots \mu_q}^{ABC \dots U} dx^{\mu_1} \wedge \dots \wedge dx^{\mu_q}$$

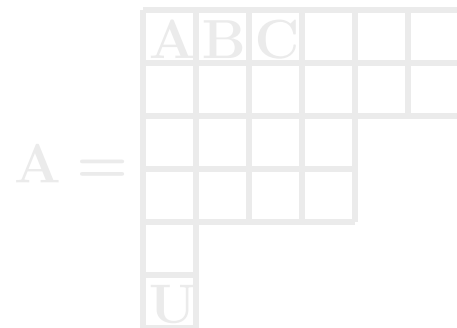

of $\mathfrak{so}(d, 1)$ or $\mathfrak{so}(d - 1, 2)$

Generalized Yang-Mills Connections

(Alkalaev, Shaynkman, Skvortsov, Vasiliev)

Yang-Mills Connection

$$W_{\mu}^{A,B} dx^{\mu}$$

one-form in adjoint = \mathfrak{g}



Generalized Yang-Mills Connection

q -form in arbitrary module A

$$W_q^A \equiv W_{\mu_1 \dots \mu_q}^{ABC \dots U} dx^{\mu_1} \wedge \dots \wedge dx^{\mu_q}$$

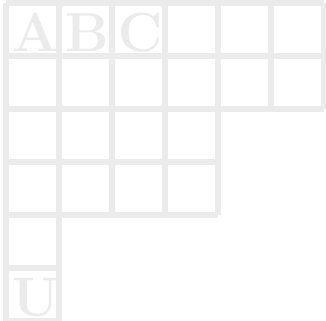
$A =$  of $\mathfrak{so}(d, 1)$ or $\mathfrak{so}(d - 1, 2)$

Generalized Yang-Mills Connections

(Alkalaev, Shaynkman, Skvortsov, Vasiliev)

Yang-Mills Connection

$$W_{\mu}^{A,B} dx^{\mu}$$

one-form in adjoint = \mathfrak{g}



Generalized Yang-Mills Connection

q -form in arbitrary module A

$$W_{\mathfrak{q}}^A \equiv W_{\mu_1 \dots \mu_q}^{ABC \dots U} dx^{\mu_1} \wedge \dots \wedge dx^{\mu_q}$$

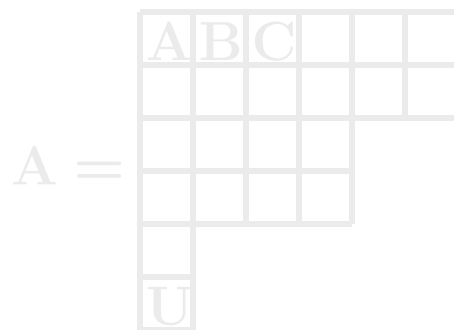

of $\mathfrak{so}(d, 1)$ or $\mathfrak{so}(d - 1, 2)$

Generalized Yang-Mills Connections

(Alkalaev, Shaynkman, Skvortsov, Vasiliev)

Yang-Mills Connection

$$W_{\mu}^{A,B} dx^{\mu}$$

one-form in adjoint = \square



Generalized Yang-Mills Connection

q -form in arbitrary module A

$$W_{\mathfrak{q}}^A \equiv W_{\mu_1 \dots \mu_q}^{ABC \dots U} dx^{\mu_1} \wedge \dots \wedge dx^{\mu_q}$$

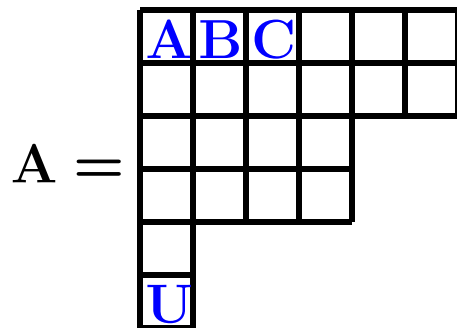

of $\mathfrak{so}(d, 1)$ or $\mathfrak{so}(d - 1, 2)$

Gauging with Generalized Connections

(Alkalaev, Shaynkman, Skvortsov, Vasiliev)

$$d\Omega^{A,B} + \Omega^{A,C} \wedge \Omega^{C,B} = 0 \quad (A)dS_d$$

Covariant derivative

$$D_\Omega W_q^{ABC\dots} \equiv dW_q^{ABC\dots} + \Omega^A_M \wedge W_q^{MBC\dots} + \dots$$

$$D_\Omega^2 = 0$$

Bianchi Identities

$$D_\Omega R_{q+1}^A = 0$$

Field Strength

$$R_{q+1}^A = D_\Omega W_q^A$$

Gauge Transformations

$$\delta W_q^A = D_\Omega \xi_{q-1}^A$$

Reducible Gauge Transformations

$$\delta \xi_{q-1}^A = D_\Omega \xi_{q-2}^A$$

Manifest (anti)-de Sitter and gauge symmetry

What theory does W_q^A describe?

Gauging with Generalized Connections

(Alkalaev, Shaynkman, Skvortsov, Vasiliev)

$$d\Omega^{A,B} + \Omega^{A, C} \wedge \Omega^{C,B} = 0 \quad (A)dS_d$$

Covariant derivative

$$D_\Omega W_q^{ABC\dots} \equiv dW_q^{ABC\dots} + \Omega^{A, M} \wedge W_q^{MBC\dots} + \dots$$
$$D_\Omega^2 = 0$$

Bianchi Identities

$$D_\Omega R_{q+1}^A = 0$$

Field Strength

$$R_{q+1}^A = D_\Omega W_q^A$$

Gauge Transformations

$$\delta W_q^A = D_\Omega \xi_{q-1}^A$$

Reducible Gauge Transformations

$$\delta \xi_{q-1}^A = D_\Omega \xi_{q-2}^A$$

Manifest (anti)-de Sitter and gauge symmetry

What theory does W_q^A describe?

Gauging with Generalized Connections

(Alkalaev, Shaynkman, Skvortsov, Vasiliev)

$$d\Omega^{A,B} + \Omega^{A, C} \wedge \Omega^{C,B} = 0 \quad (A)dS_d$$

Covariant derivative

$$D_\Omega W_q^{ABC\dots} \equiv dW_q^{ABC\dots} + \Omega^{A, M} \wedge W_q^{MBC\dots} + \dots$$
$$D_\Omega^2 = 0$$

Bianchi Identities

Field Strength

Gauge Transformations

Reducible Gauge Transformations

$$D_\Omega R_{q+1}^A = 0$$

$$R_{q+1}^A = D_\Omega W_q^A$$

$$\delta W_q^A = D_\Omega \xi_{q-1}^A$$

$$\delta \xi_{q-1}^A = D_\Omega \xi_{q-2}^A$$

Manifest (anti)-de Sitter and gauge symmetry

What theory does W_q^A describe?

Gauging with Generalized Connections

(Alkalaev, Shaynkman, Skvortsov, Vasiliev)

$$d\Omega^{A,B} + \Omega^{A, C} \wedge \Omega^{C,B} = 0 \quad (A)dS_d$$

Covariant derivative

$$D_\Omega W_q^{ABC\dots} \equiv dW_q^{ABC\dots} + \Omega^{A, M} \wedge W_q^{MBC\dots} + \dots$$
$$D_\Omega^2 = 0$$

Bianchi Identities

Field Strength

Gauge Transformations

Reducible Gauge Transformations

$$D_\Omega R_{q+1}^A = 0$$

$$R_{q+1}^A = D_\Omega W_q^A$$

$$\delta W_q^A = D_\Omega \xi_{q-1}^A$$

$$\delta \xi_{q-1}^A = D_\Omega \xi_{q-2}^A$$

Manifest (anti)-de Sitter and gauge symmetry

What theory does W_q^A describe?

Gauging with Generalized Connections

(Alkalaev, Shaynkman, Skvortsov, Vasiliev)

$$d\Omega^{A,B} + \Omega^{A, C} \wedge \Omega^{C,B} = 0 \quad (A)dS_d$$

Covariant derivative

$$D_\Omega W_q^{ABC\dots} \equiv dW_q^{ABC\dots} + \Omega^{A, M} \wedge W_q^{MBC\dots} + \dots$$
$$D_\Omega^2 = 0$$

Bianchi Identities

$$D_\Omega R_{q+1}^A = 0$$

Field Strength

$$R_{q+1}^A = D_\Omega W_q^A$$

Gauge Transformations

$$\delta W_q^A = D_\Omega \xi_{q-1}^A$$

Reducible Gauge Transformations

$$\delta \xi_{q-1}^A = D_\Omega \xi_{q-2}^A$$

Manifest (anti)-de Sitter and gauge symmetry

What theory does W_q^A describe?

What should we expect?

Simplest gauge fields

massless spin-2

$$\delta\phi_{\mu\nu} = D_\mu\xi_\nu + D_\nu\xi_\mu$$

p.d.o.f. = $\pm 2, \pm 1, 0$

partially-massless spin-2
(Deser, Nepomechie)

$$\delta\phi_{\mu\nu} = D_\mu D_\nu\xi + \lambda^2 g_{\mu\nu}\xi$$

p.d.o.f. = $\pm 2, \pm 1, 0$

massless spin- s
(Fronsdal, Vasiliev)

$$\delta\phi_{\mu_1\dots\mu_s} = D_{\mu_1}\xi_{\mu_2\dots\mu_s} + \text{permutations}$$

p.d.o.f. = $\pm s, \pm(s-1), \dots, 0$

partially-massless spin- s
(Deser, Waldron, Higuchi)
(Witten, Zinoviev)

$$\delta\phi_{\mu_1\dots\mu_s} = D_{\mu_1}\dots D_{\mu_t}\xi_{\mu_{t+1}\dots\mu_s} + \dots$$

p.d.o.f. = $\pm s, \dots, \pm(s-t), \pm(s-t-1), \dots, 0$

What should we expect?

Simplest gauge fields

massless spin-2

$$\delta\phi_{\mu\nu} = D_\mu\xi_\nu + D_\nu\xi_\mu$$

p.d.o.f. = $\pm 2, \pm 1, 0$

partially-massless spin-2
(Deser, Nepomechie)

$$\delta\phi_{\mu\nu} = D_\mu D_\nu \xi + \lambda^2 g_{\mu\nu} \xi$$

p.d.o.f. = $\pm 2, \pm 1, 0$

massless spin- s
(Fronsdal, Vasiliev)

$$\delta\phi_{\mu_1 \dots \mu_s} = D_{\mu_1} \xi_{\mu_2 \dots \mu_s} + \text{permutations}$$

p.d.o.f. = $\pm s, \pm(s-1), \dots, 0$

partially-massless spin- s
(Deser, Waldron, Higuchi)
(Witten, Zinoviev)

$$\delta\phi_{\mu_1 \dots \mu_s} = D_{\mu_1} \dots D_{\mu_t} \xi_{\mu_{t+1} \dots \mu_s} + \dots$$

p.d.o.f. = $\pm s, \dots, \pm(s-t), \pm(s-t-1), \dots, 0$

What should we expect?

Simplest gauge fields

massless spin-2

$$\delta\phi_{\mu\nu} = D_\mu\xi_\nu + D_\nu\xi_\mu$$

p.d.o.f. = $\pm 2, \pm 1, 0$

partially-massless spin-2
(Deser, Nepomechie)

$$\delta\phi_{\mu\nu} = D_\mu D_\nu \xi + \lambda^2 g_{\mu\nu} \xi$$

p.d.o.f. = $\pm 2, \pm 1, 0$

massless spin- s
(Fronsdal, Vasiliev)

$$\delta\phi_{\mu_1 \dots \mu_s} = D_{\mu_1} \xi_{\mu_2 \dots \mu_s} + \text{permutations}$$

p.d.o.f. = $\pm s, \pm(s-1), \dots, 0$

partially-massless spin- s
(Deser, Waldron, Higuchi)
(Witten, Zinoviev)

$$\delta\phi_{\mu_1 \dots \mu_s} = D_{\mu_1} \dots D_{\mu_t} \xi_{\mu_{t+1} \dots \mu_s} + \dots$$

p.d.o.f. = $\pm s, \dots, \pm(s-t), \pm(s-t-1), \dots, 0$

What should we expect?

Simplest gauge fields

massless spin-2

$$\delta\phi_{\mu\nu} = D_\mu\xi_\nu + D_\nu\xi_\mu$$

p.d.o.f. = $\pm 2, \pm 1, 0$

partially-massless spin-2
(Deser, Nepomechie)

$$\delta\phi_{\mu\nu} = D_\mu D_\nu \xi + \lambda^2 g_{\mu\nu} \xi$$

p.d.o.f. = $\pm 2, \pm 1, 0$

massless spin- s
(Fronsdal, Vasiliev)

$$\delta\phi_{\mu_1 \dots \mu_s} = D_{\mu_1} \xi_{\mu_2 \dots \mu_s} + \text{permutations}$$

p.d.o.f. = $\pm s, \pm(s-1), \dots, 0$

partially-massless spin- s
(Deser, Waldron, Higuchi)
(Witten, Zinoviev)

$$\delta\phi_{\mu_1 \dots \mu_s} = D_{\mu_1} \dots D_{\mu_t} \xi_{\mu_{t+1} \dots \mu_s} + \dots$$

p.d.o.f. = $\pm s, \dots, \pm(s-t), \pm(s-t-1), \dots, 0$

Higher-Spin fields

String theory $\xrightarrow{\alpha' \rightarrow \infty}$ higher-spin fields

(Gross, Klebanov, Sundborg, Sezgin, Bengtsson, Sagnotti, Francia, Bonelli)



Breaking HS symmetries

$$|\phi\rangle = \phi_{\mu_1 \dots \mu_s}(x) \alpha_{-1}^{\mu_1} \dots \alpha_{-1}^{\mu_s} |0\rangle$$

$\alpha_{-1}^{\mu} \dots \alpha_{-k}^{\nu}$ - mixed-symmetry fields

What should we expect?

General case

(Alkalaev, Skvortsov, Metsaev, Vasiliev)

Spin of the field
 S_0

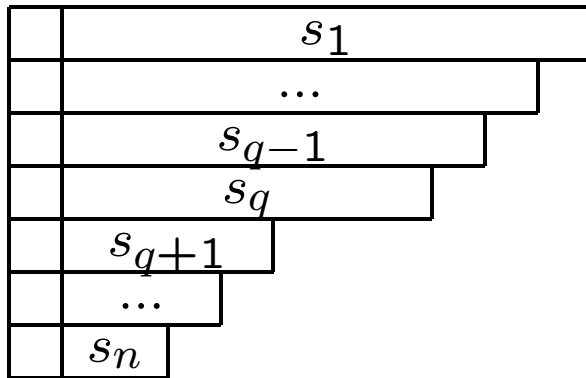

Spin of the gauge parameter
 S_1

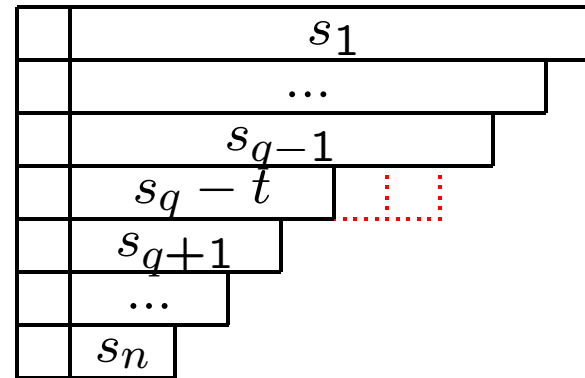

$$\delta\phi^{S_0} = \overbrace{D \dots D}^t \xi^{S_1} + \dots$$

Gauge Fields in $(A)dS_d \iff (S, q, t)$

The way it works

Simplest cases



$$A = \begin{bmatrix} 1 \\ 0 \end{bmatrix}, \quad q = 1$$

$$W_1^{A,B}$$

$$\delta W_1^{A,B} = D_\Omega \xi_0^{A,B}$$

$$\phi_{\mu\nu} = W_\mu^{c,\bullet} h_{c\nu} + W_\nu^{c,\bullet} h_{c\mu}$$

$$\delta \phi_{\mu\nu} = D_\mu \xi_\nu + D_\nu \xi_\mu$$

$$\xi_\mu = \xi^{c,\bullet} h_{c\mu}$$

$$A = \begin{bmatrix} s-1 \\ s-t \end{bmatrix}, \quad q = 1$$

$$\phi_{\mu_1 \dots \mu_s} = W_{\mu_1}^{a \dots c, \bullet \dots \bullet} h_{a\mu_2 \dots \mu_s} + \dots$$

$$\delta \phi_{\mu_1 \dots \mu_s} = D_{\mu_1} \dots D_{\mu_t} \xi_{\mu_{t+1} \dots \mu_s} + \dots$$

$$\xi_{\mu_1 \dots \mu_{s-t}} = \xi^{a \dots c, \bullet \dots \bullet, \bullet \dots \bullet} h_{a\mu_1 \dots \mu_{s-t}}$$

The way it works

Simplest cases



$$A = \begin{bmatrix} 1 \\ 0 \end{bmatrix}, \quad q = 1$$

$$W_1^{A,B} \\ \delta W_1^{A,B} = D_\Omega \xi_0^{A,B}$$

$$\begin{aligned} \phi_{\mu\nu} &= W_\mu^{c,\bullet} h_{c\nu} + W_\nu^{c,\bullet} h_{c\mu} \\ \delta\phi_{\mu\nu} &= D_\mu \xi_\nu + D_\nu \xi_\mu \\ \xi_\mu &= \xi^{c,\bullet} h_{c\nu} \end{aligned}$$

$$A = \begin{bmatrix} s-1 \\ s-t \end{bmatrix}, \quad q = 1$$

$$\begin{aligned} \phi_{\mu_1 \dots \mu_s} &= W_{\mu_1}^{a \dots c, \bullet \dots \bullet} h_{a\mu_2 \dots} h_{c\mu_s} + \dots \\ \delta\phi_{\mu_1 \dots \mu_s} &= D_{\mu_1} \dots D_{\mu_t} \xi_{\mu_{t+1} \dots \mu_s} + \dots \\ \xi_{\mu_1 \dots \mu_{s-t}} &= \xi^{a \dots c, \bullet \dots \bullet, \bullet \dots \bullet} h_{a\mu_1 \dots} h_{c\mu_{s-t}} \end{aligned}$$

The way it works

Simplest cases



$$A = \begin{array}{|c|} \hline \square \\ \hline \end{array}, \quad q = 1$$

$$W_1^{A,B} \\ \delta W_1^{A,B} = D_\Omega \xi_0^{A,B}$$

$$\begin{aligned} \phi_{\mu\nu} &= W_\mu^{c,\bullet} h_{c\nu} + W_\nu^{c,\bullet} h_{c\mu} \\ \delta \phi_{\mu\nu} &= D_\mu \xi_\nu + D_\nu \xi_\mu \\ \xi_\mu &= \xi^{c,\bullet} h_{c\nu} \end{aligned}$$

$$A = \begin{array}{|c|} \hline \begin{array}{|c|} \hline s-1 \\ \hline \end{array} \\ \hline \begin{array}{|c|} \hline s-t \\ \hline \end{array} \\ \hline \end{array}, \quad q = 1$$

$$\begin{aligned} \phi_{\mu_1 \dots \mu_s} &= W_{\mu_1}^{a \dots c, \bullet \dots \bullet} h_{a\mu_2 \dots \mu_s} + \dots \\ \delta \phi_{\mu_1 \dots \mu_s} &= D_{\mu_1} \dots D_{\mu_t} \xi_{\mu_{t+1} \dots \mu_s} + \dots \\ \xi_{\mu_1 \dots \mu_{s-t}} &= \xi^{a \dots c, \bullet \dots \bullet, \bullet \dots \bullet} h_{a\mu_1 \dots \mu_{s-t}} \end{aligned}$$

Gauge Fields vs. Gauge Connections

Lorentz metric-like

$$\mathfrak{so}(d-1, 1)$$

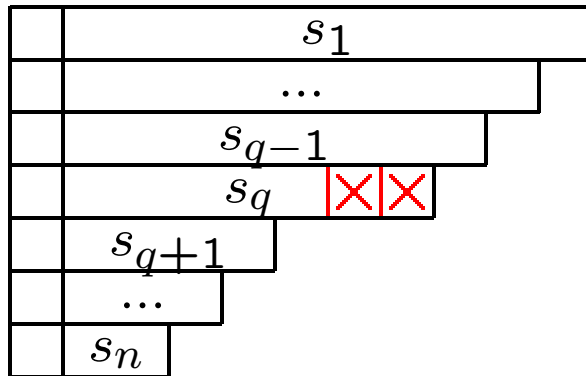

$$\delta\phi^{\mathbf{S}_0} = \overbrace{D \dots D}^t \xi^{\mathbf{S}_1} + \dots$$

extremely complicated

Connection

$$\mathfrak{so}(d, 1) \text{ or } \mathfrak{so}(d-1, 2)$$

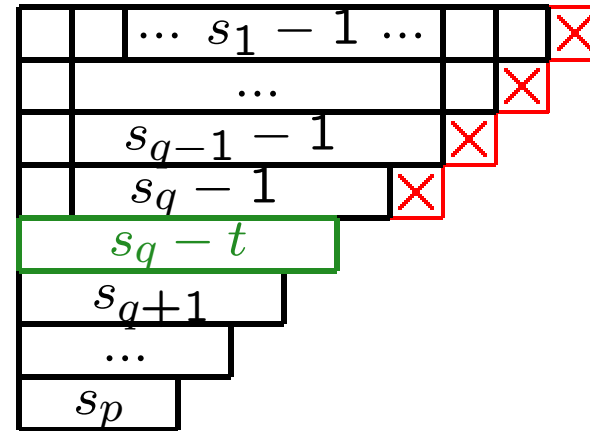

$$\delta W_q^{\mathbf{A}} = D_{\Omega} \xi_{q-1}^{\mathbf{A}}$$

$$R_{q+1}^{\mathbf{A}} = D_{\Omega} W_q^{\mathbf{A}}$$

Great simplifications

Conclusions

$(A)dS_d$ -Gauge Fields



Yang-Mills Connections

- Manifest gauge invariance
- Manifest $(A)dS_d$ covariance
- Manifest general covariance
- Nonlinear theory?? \longrightarrow String theory